

Pianta Scarpa in gomma in 2D

Prof. Pisani Antonio

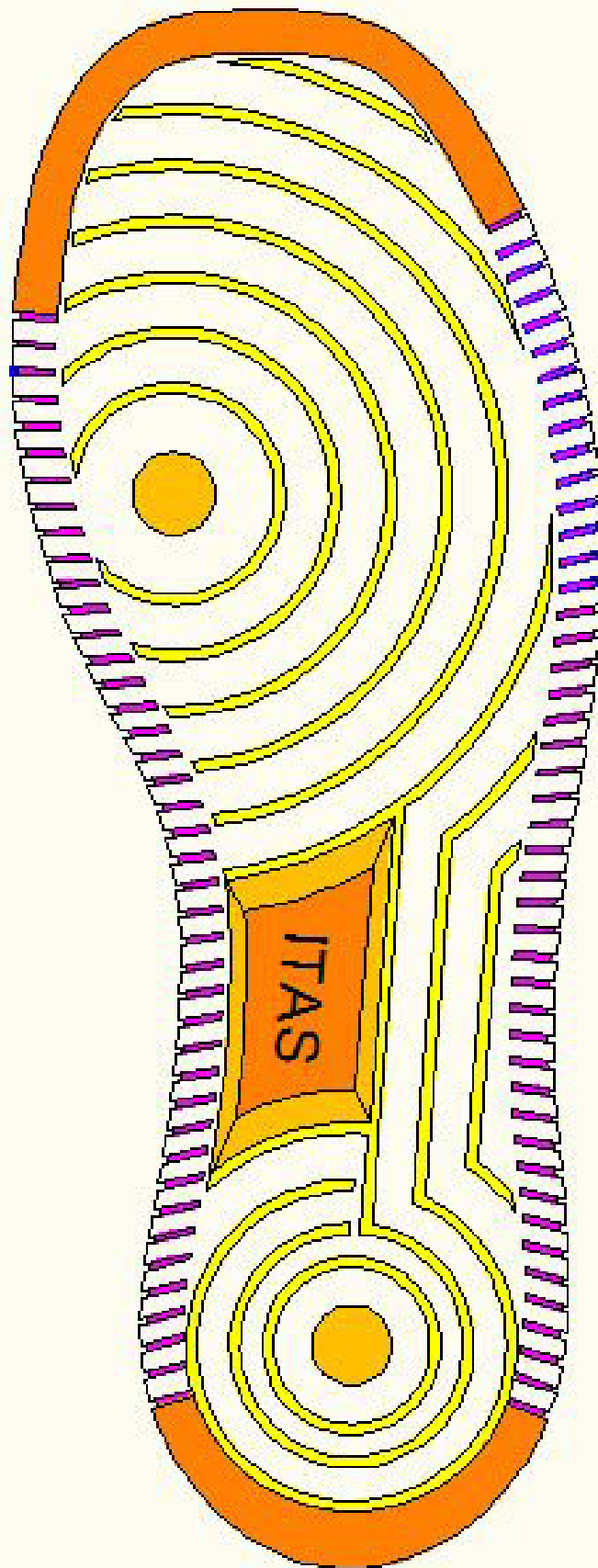

Pianta scarpa in gomma in 2D

VISTA DAL BASSO

Prof. Pisani Antonio

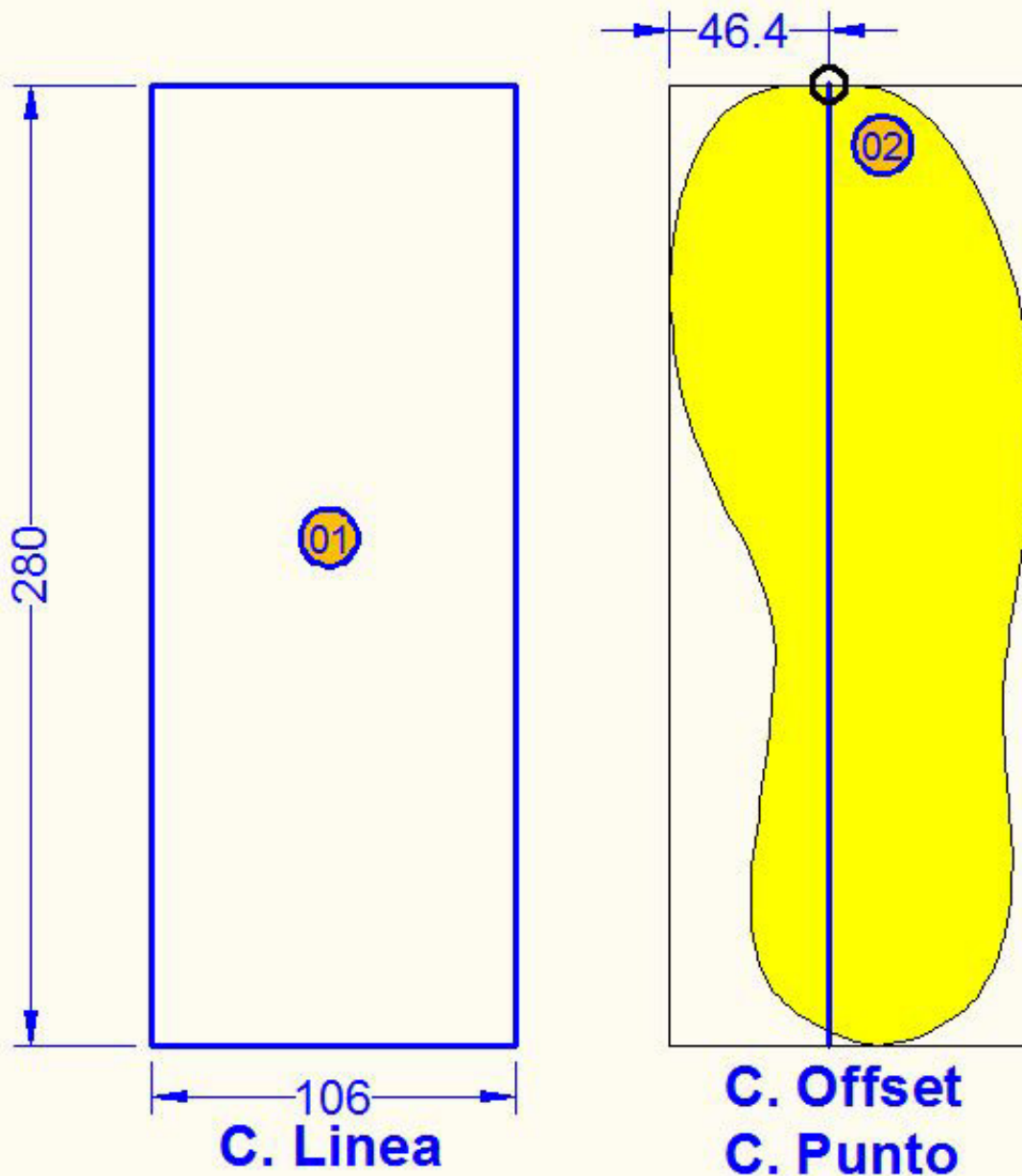

Pianta scarpa in gomma in 2D

VISTA DAL BASSO

Prof. Pisani Antonio

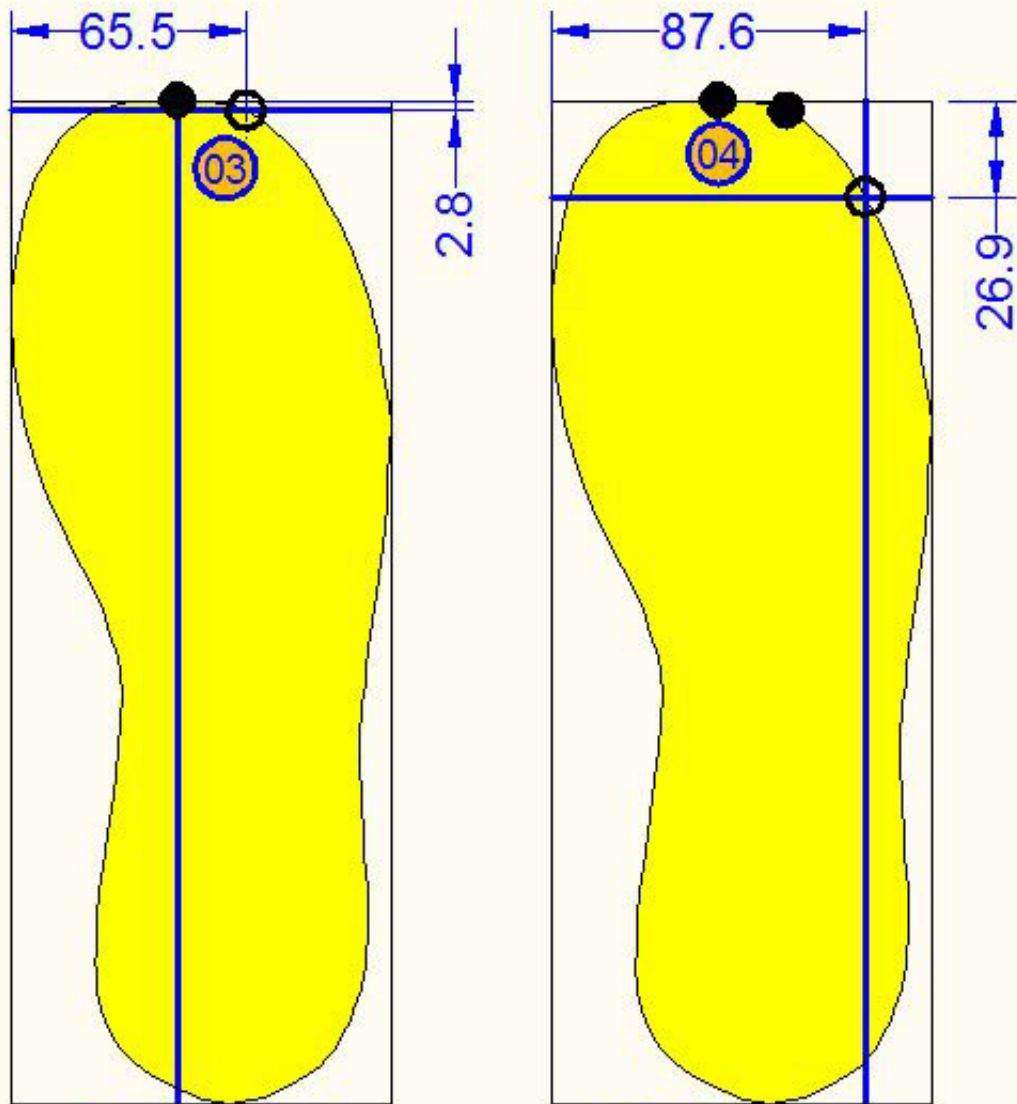

C. Offset
C. Punto

C. Offset
C. Punto

Pianta scarpa in gomma in 2D

VISTA DAL BASSO

Prof. Pisani Antonio

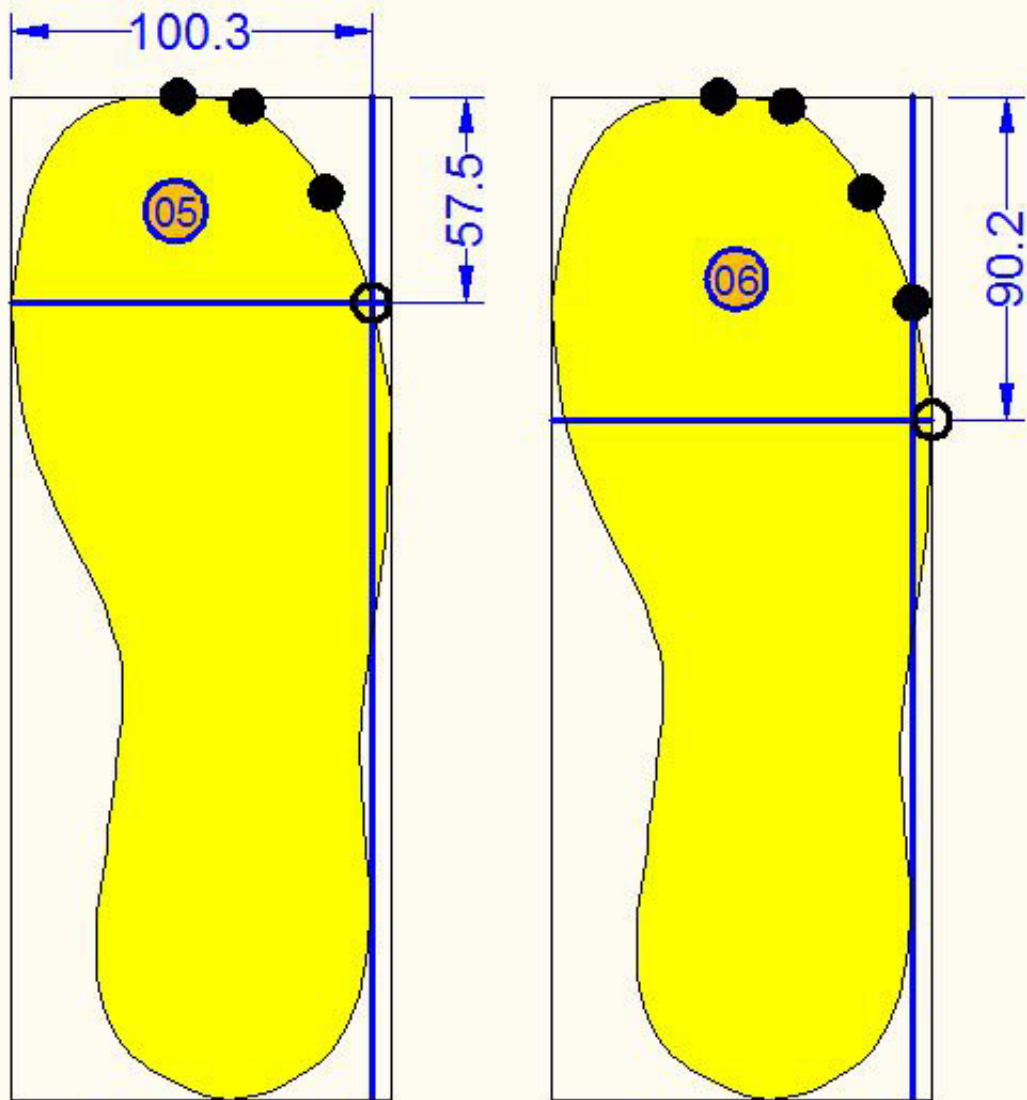

C. Offset
C. Punto

C. Offset
C. Punto

Pianta scarpa in gomma in 2D

VISTA DAL BASSO

Prof. Pisani Antonio

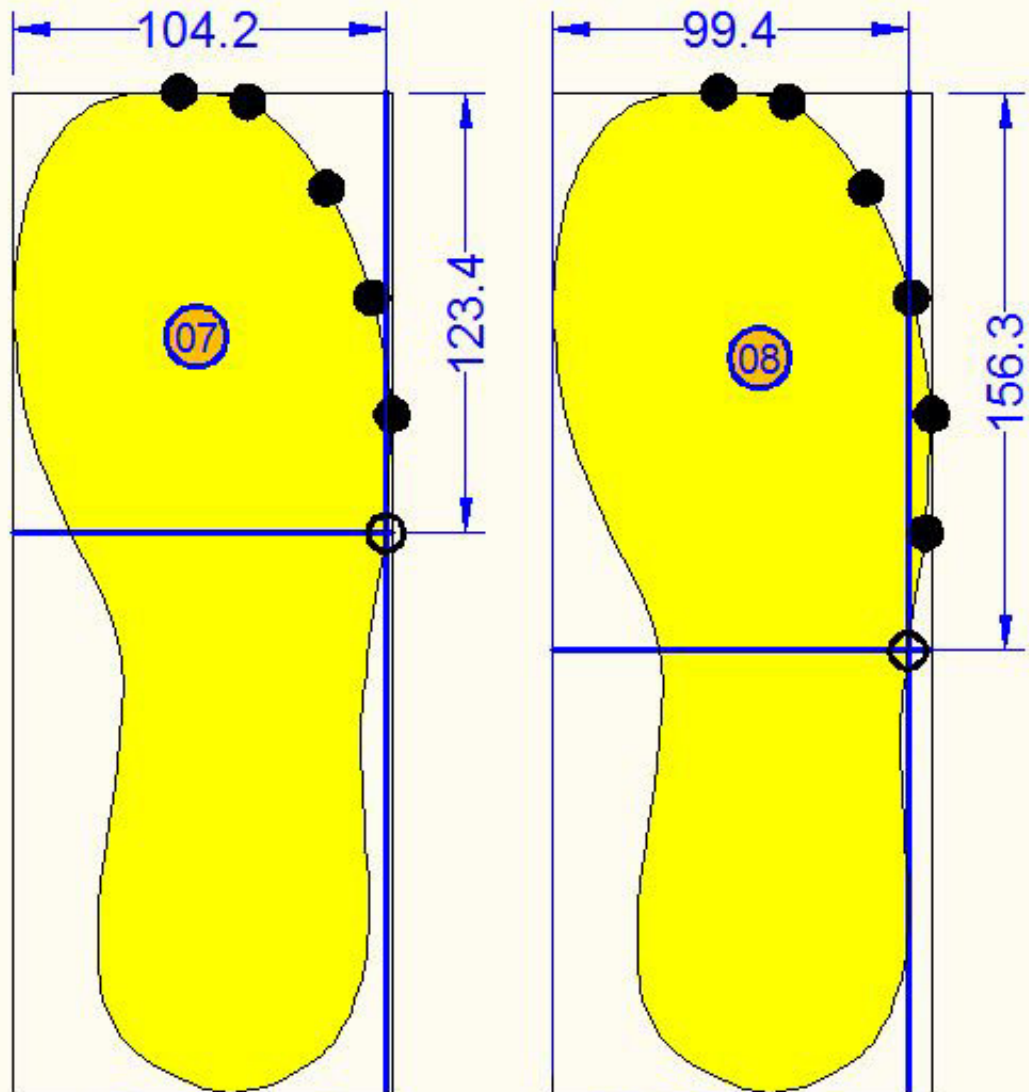

C. Offset
C. Punto

C. Offset
C. Punto

Pianta scarpa in gomma in 2D

VISTA DAL BASSO

Prof. Pisani Antonio

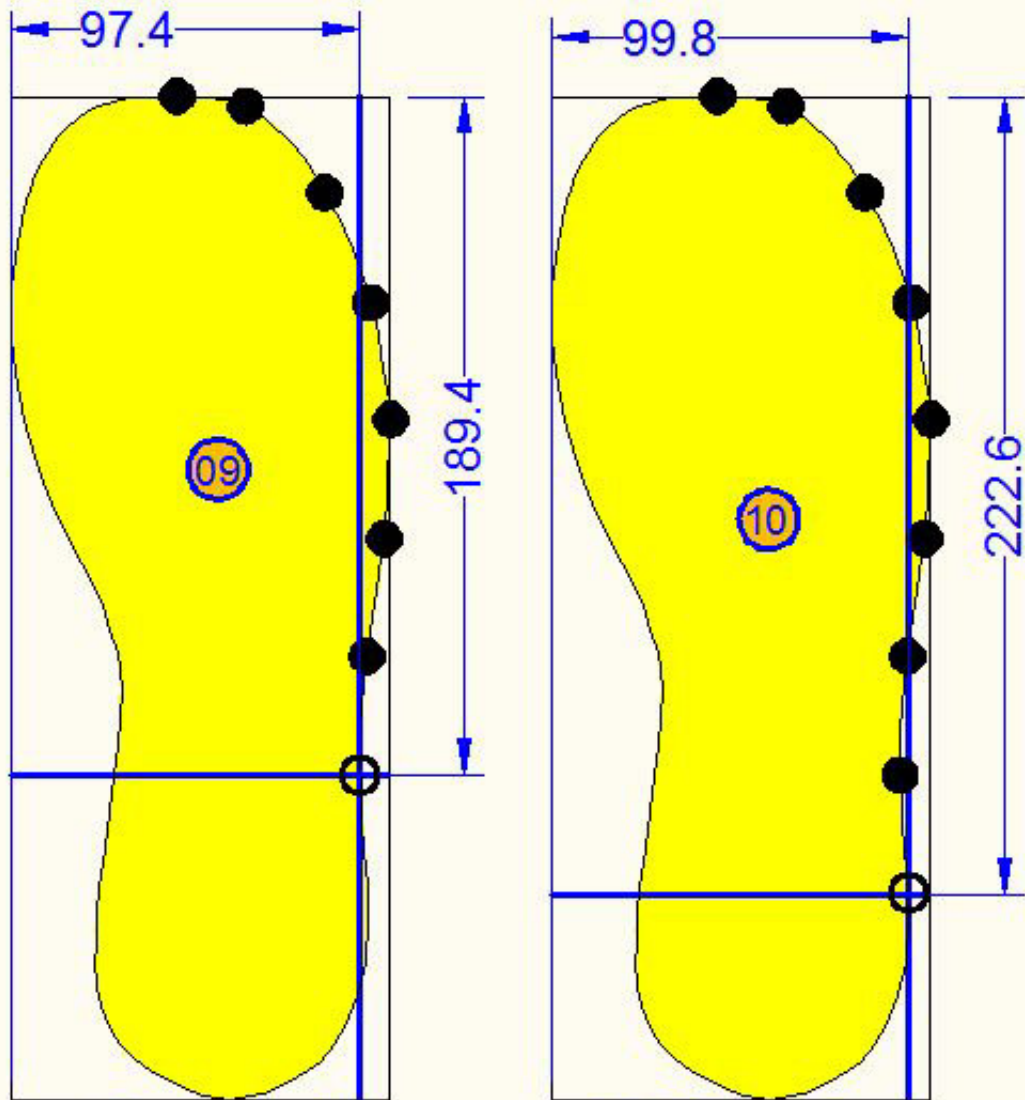

C. Offset
C. Punto

C. Offset
C. Punto

Pianta scarpa in gomma in 2D

VISTA DAL BASSO

Prof. Pisani Antonio

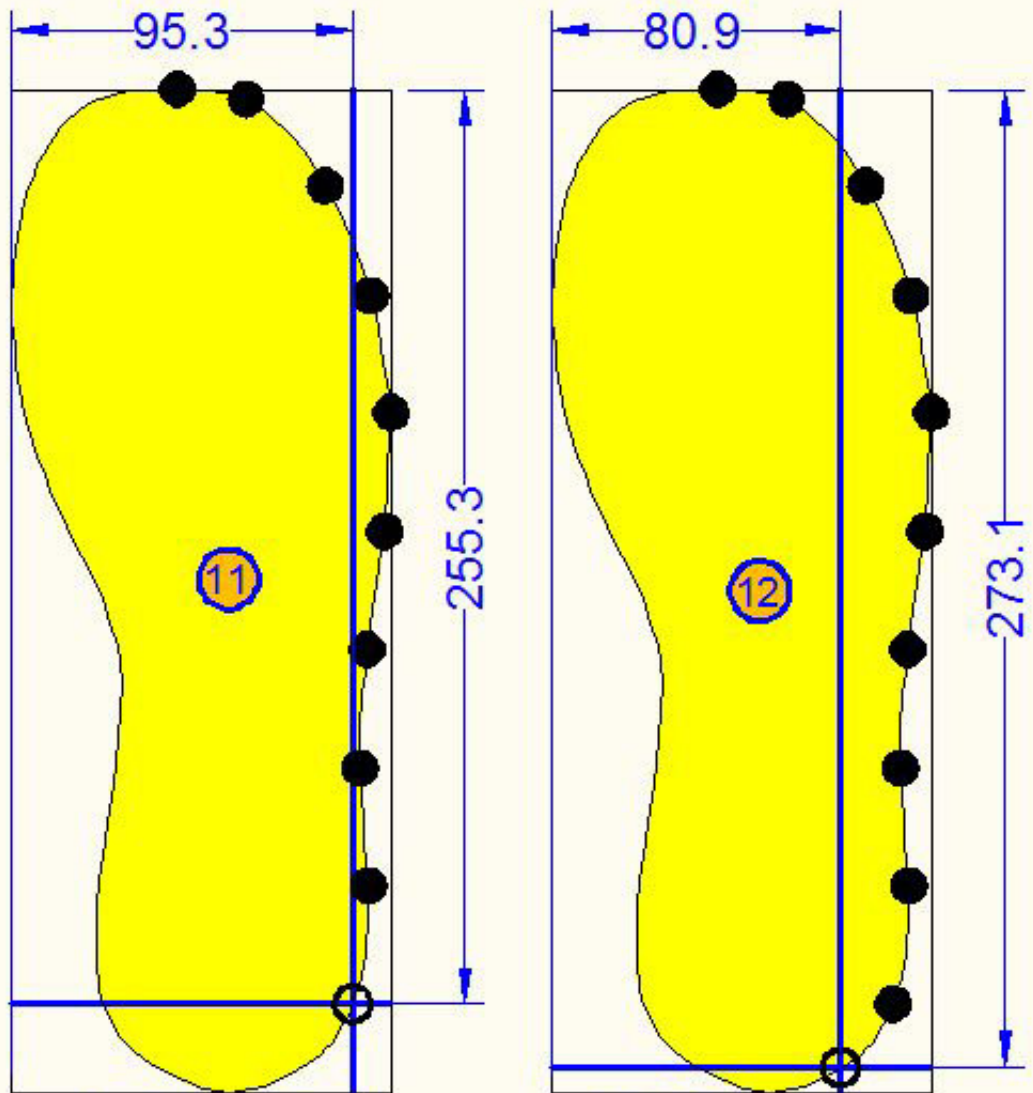

C. Offset
C. Punto

C. Offset
C. Punto

Pianta scarpa in gomma in 2D

VISTA DAL BASSO

Prof. Pisani Antonio

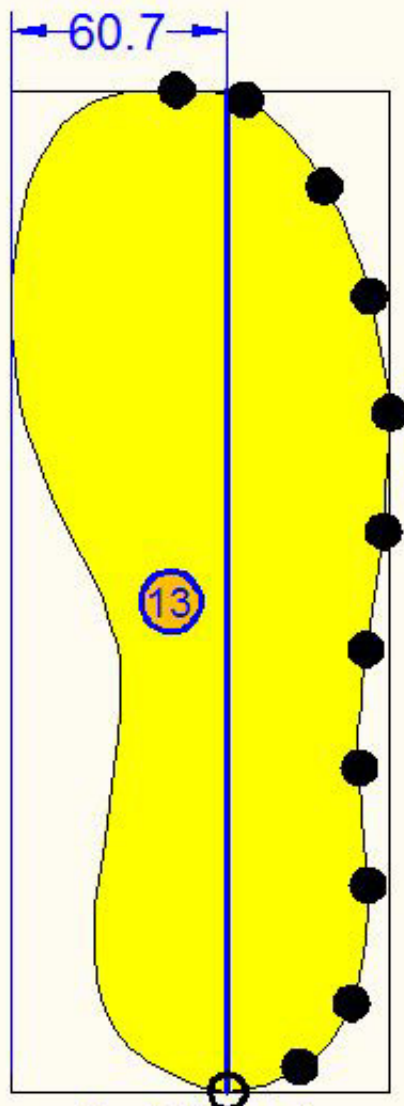

C. Offset
C. Punto

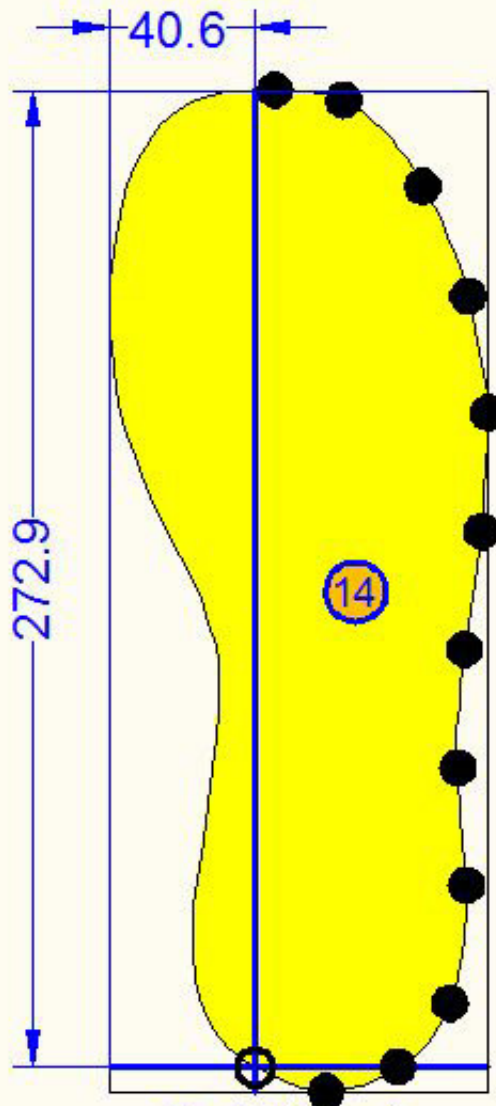

C. Offset
C. Punto

Pianta scarpa in gomma in 2D

VISTA DAL BASSO

Prof. Pisani Antonio

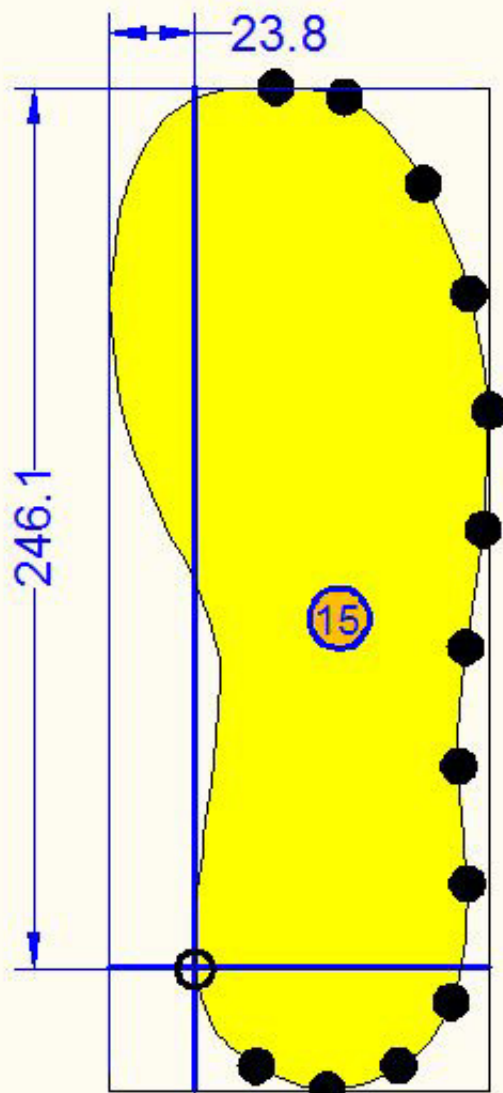

C. Offset
C. Punto

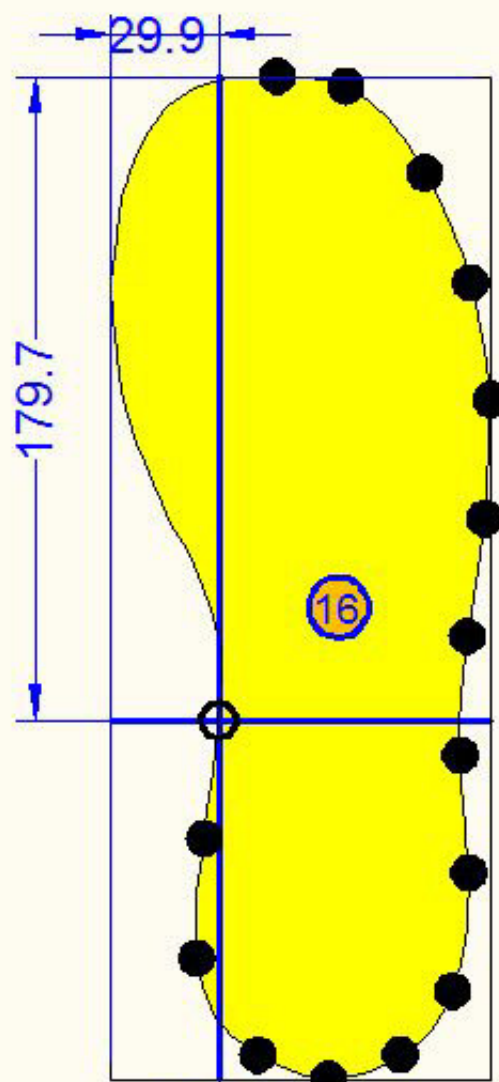

C. Offset
C. Punto

Pianta scarpa in gomma in 2D

VISTA DAL BASSO

Prof. Pisani Antonio

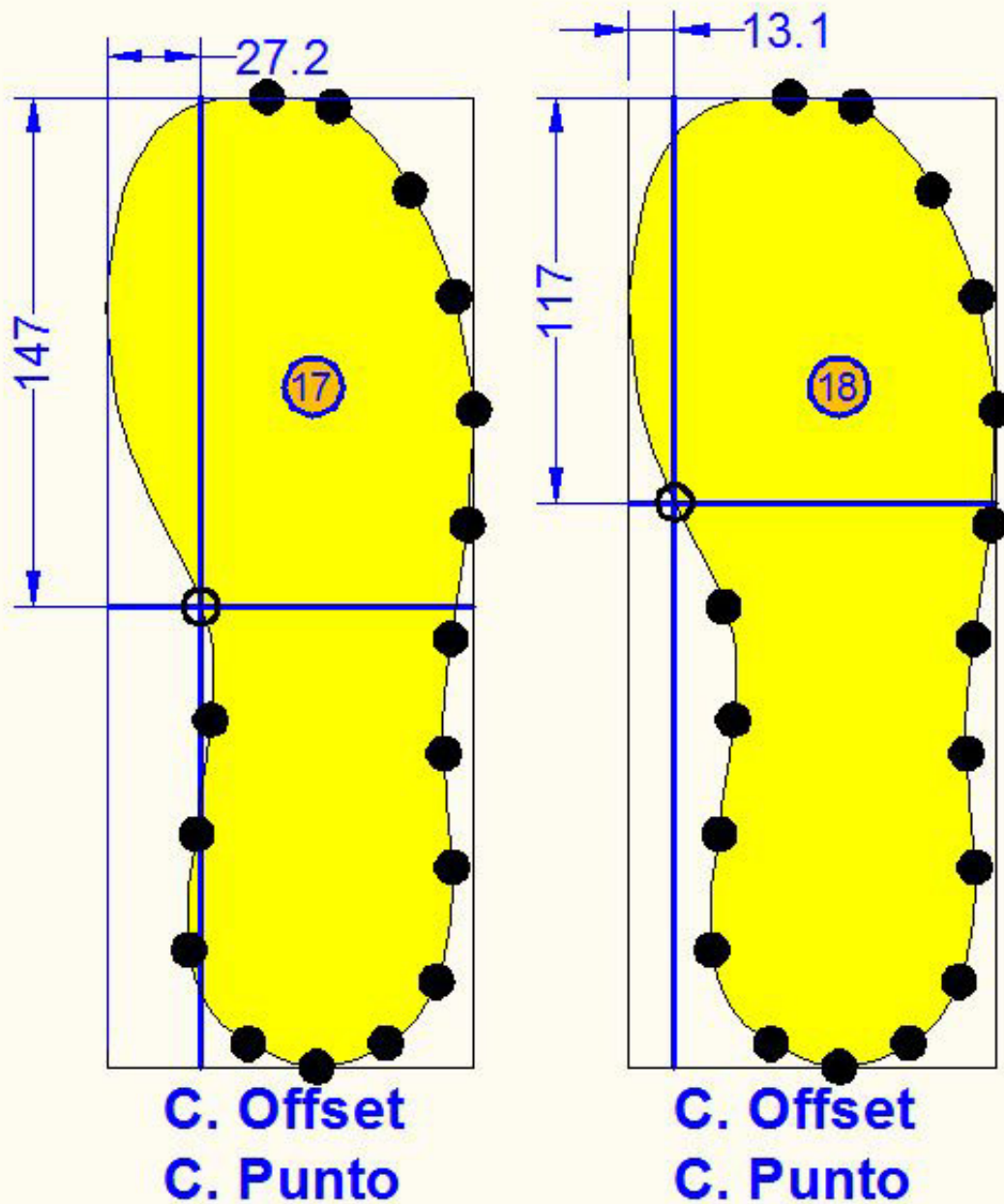

Pianta scarpa in gomma in 2D

VISTA DAL BASSO

Prof. Pisani Antonio

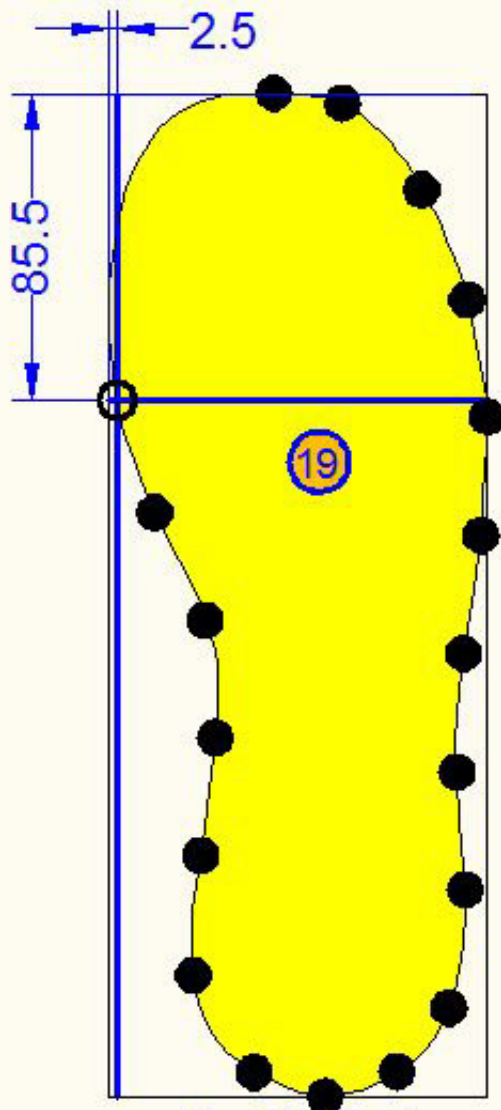

C. Offset
C. Punto

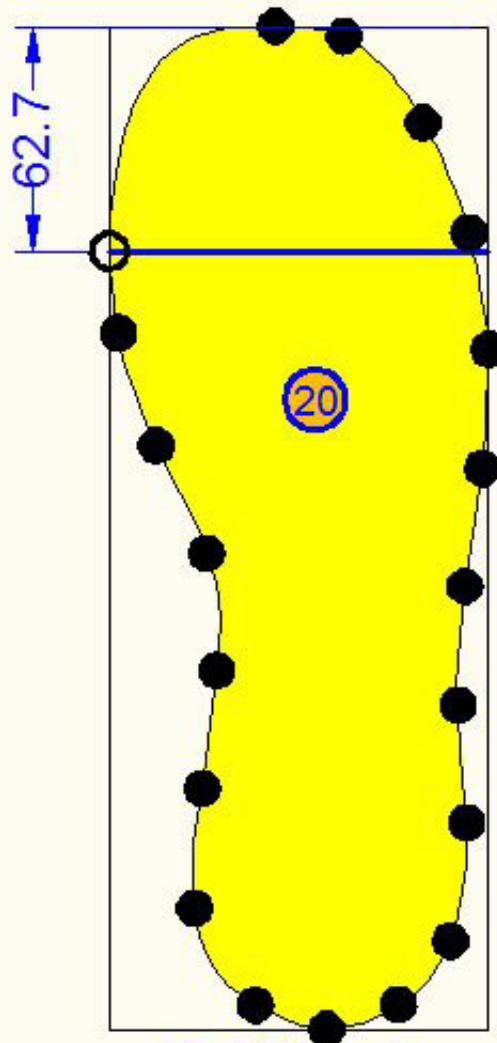

C. Offset
C. Punto

Pianta scarpa in gomma in 2D

VISTA DAL BASSO

Prof. Pisani Antonio

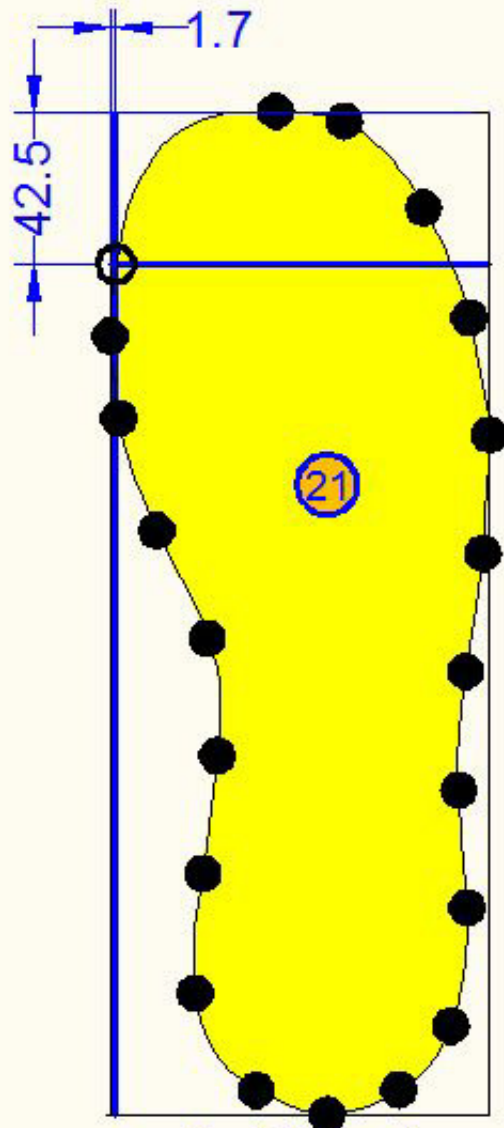

C. Offset
C. Punto

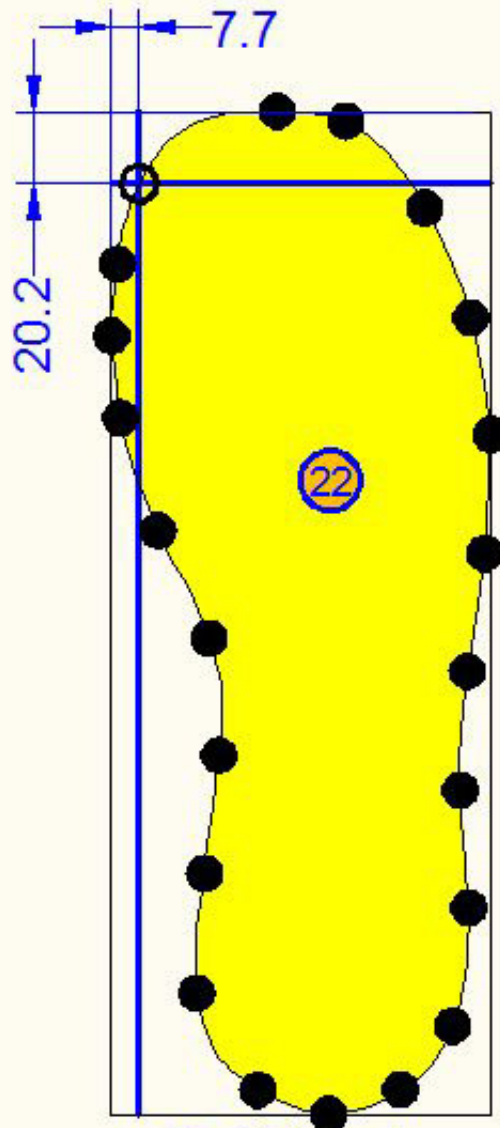

C. Offset
C. Punto

Pianta scarpa in gomma in 2D

VISTA DAL BASSO

Prof. Pisani Antonio

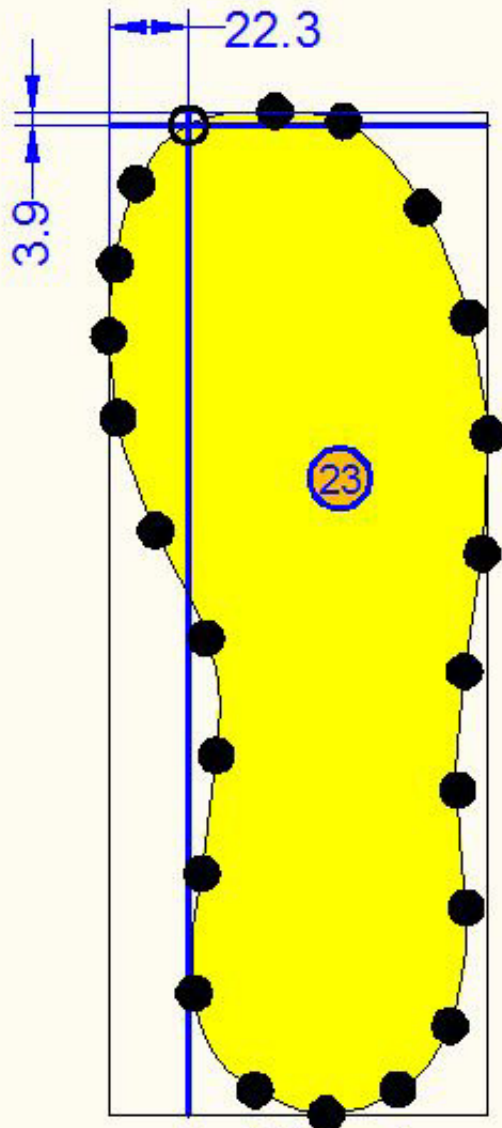

C. Offset
C. Punto

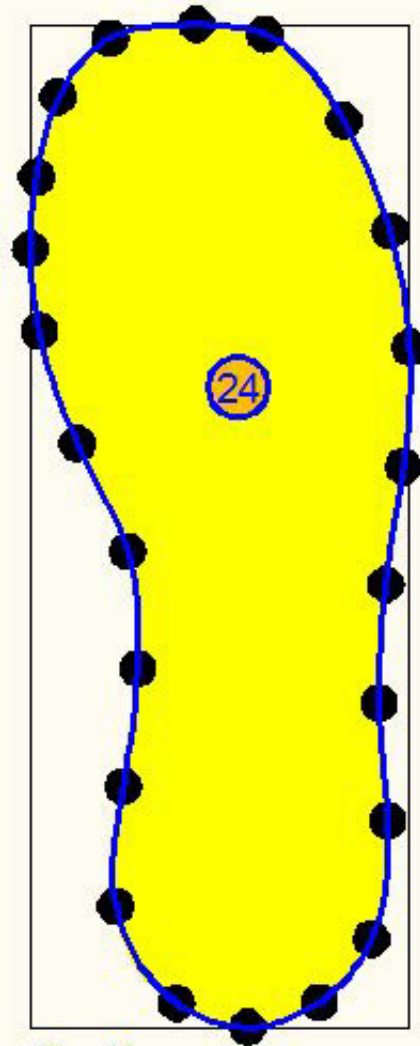

C. Spline
C. Cancella punti

Pianta scarpa in gomma in 2D

VISTA DAL BASSO

Prof. Pisani Antonio

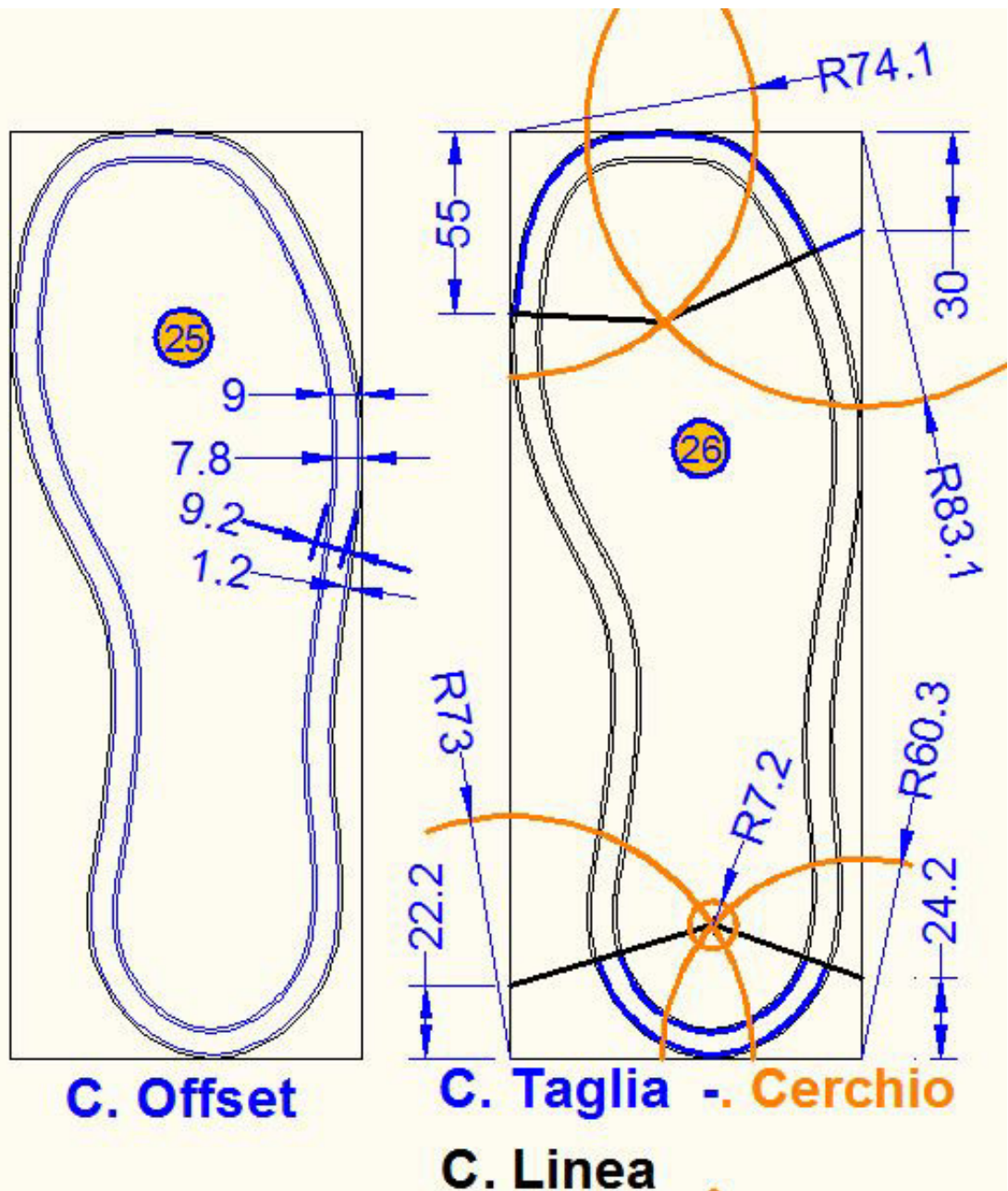

Pianta scarpa in gomma in 2D

VISTA DAL BASSO

Prof. Pisani Antonio

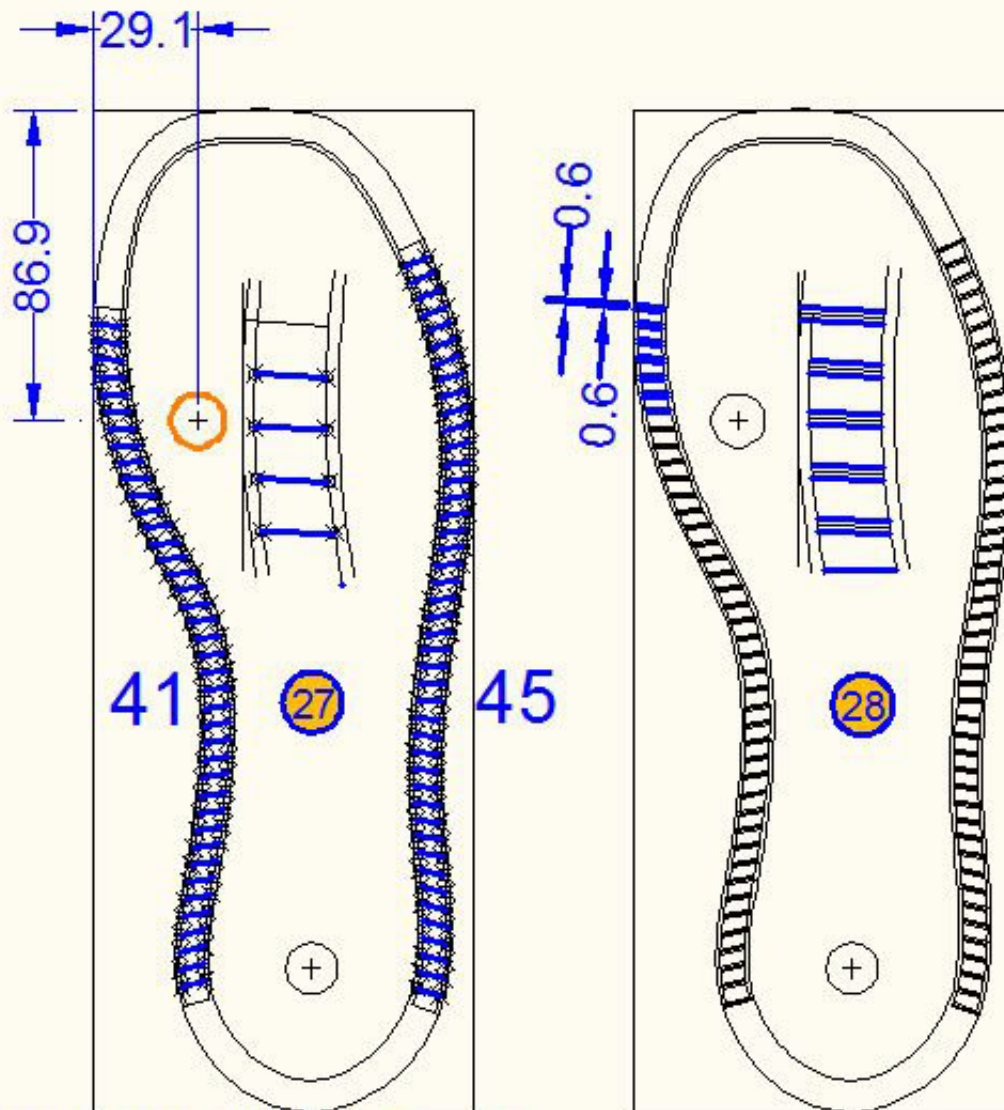

C. Dividi 41- 45- C. Cerchio
Unire i punti C.Linea

C. Offset 0.6

Pianta scarpa in gomma in 2D

VISTA DAL BASSO

Prof. Pisani Antonio

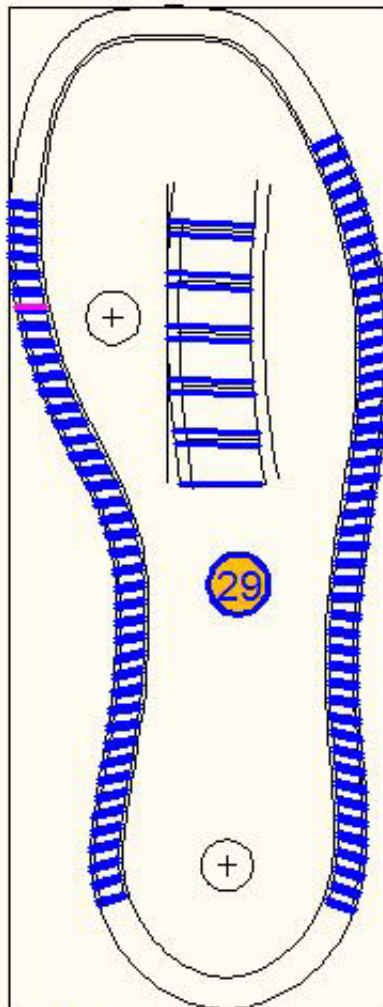

C. Estendi
C. Taglia

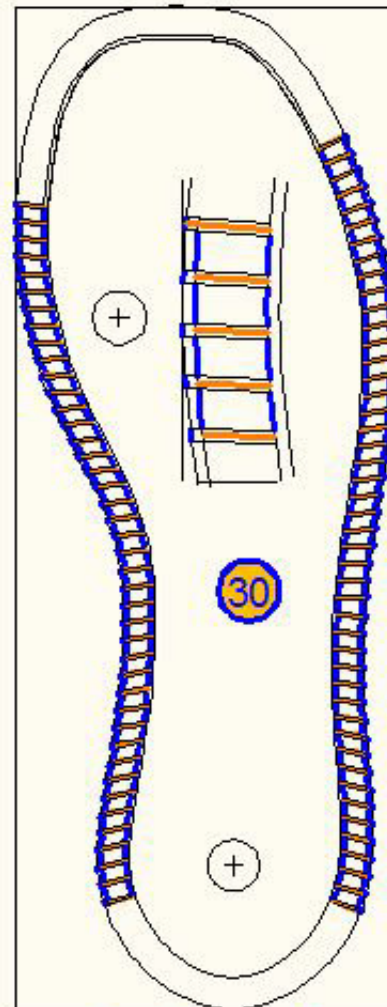

C. Cancella
C. Taglia

Pianta scarpa in gomma in 2D

VISTA DAL BASSO

Prof. Pisani Antonio

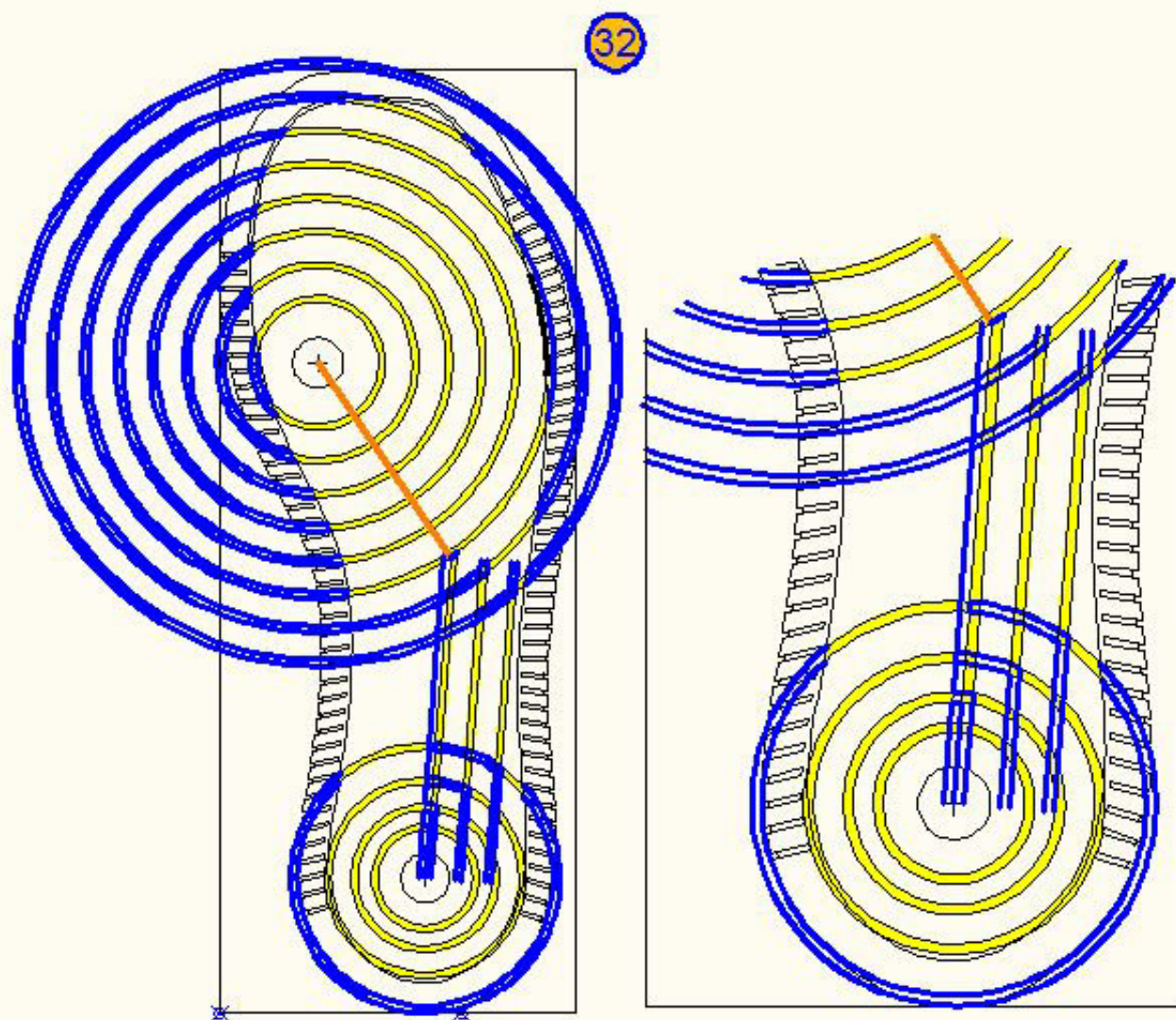

C. Taglia - C. Cancellata

Pianta scarpa in gomma in 2D

VISTA DAL BASSO

Prof. Pisani Antonio

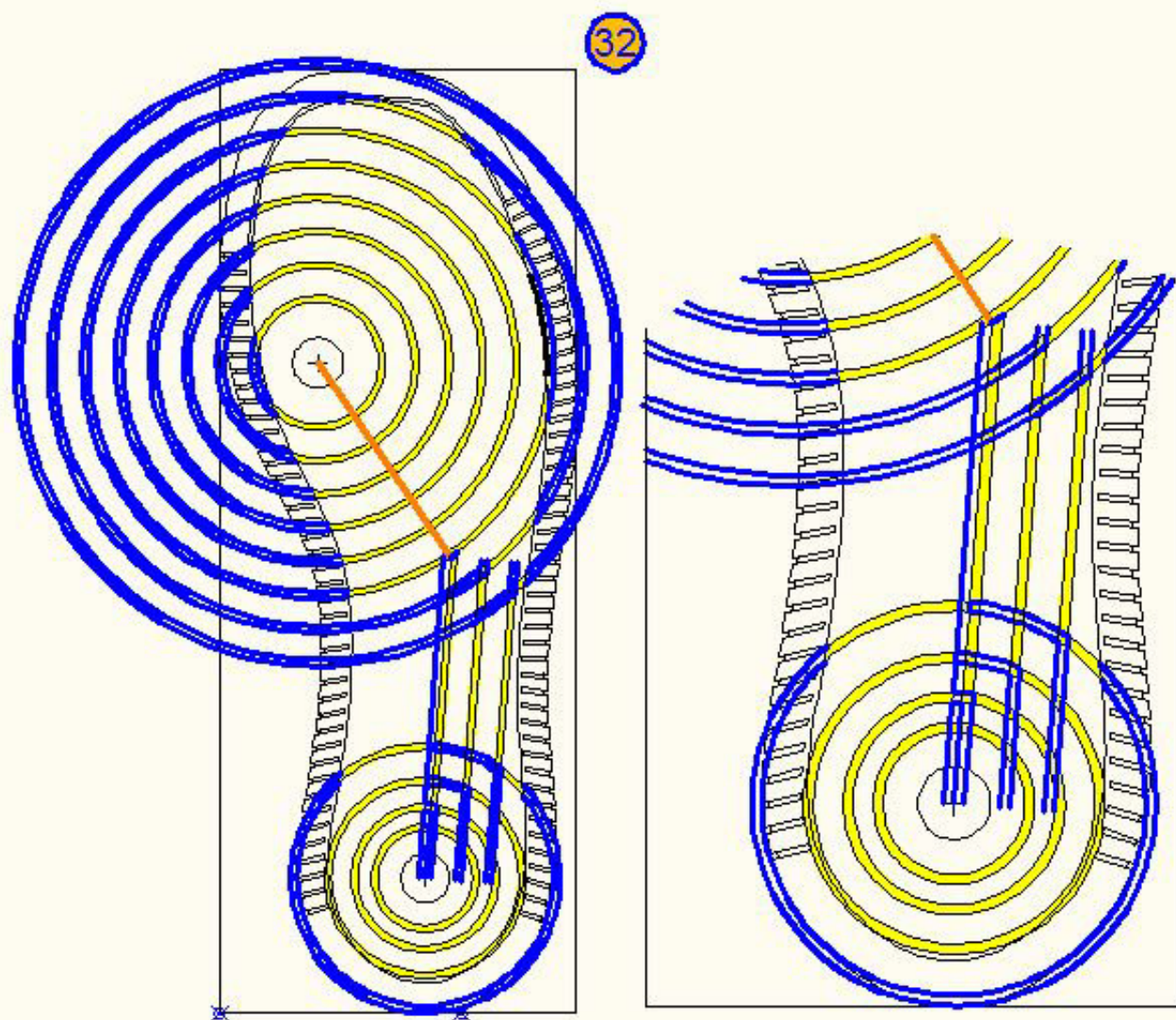

C. Taglia - C. Cancellata

Pianta scarpa in gomma in 2D

VISTA DAL BASSO

Prof. Pisani Antonio

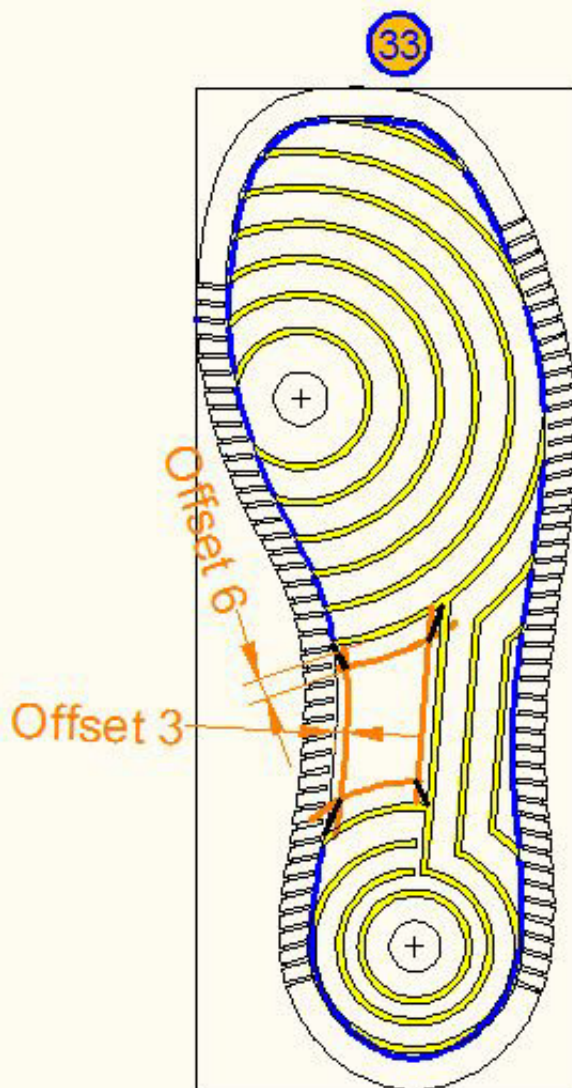

C. Cancellata - **C. Offset**
- **C. Linea**

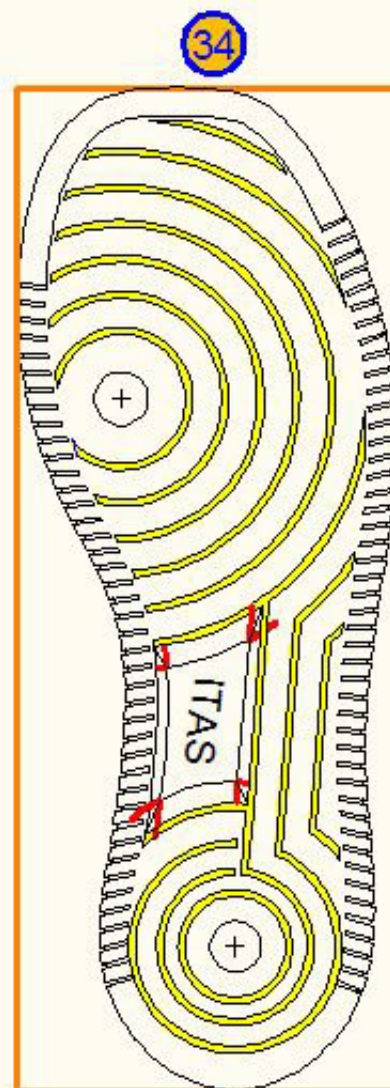

C. Taglia - - **C. Testo**
Mutilinea (ITAS)- **C.Cancellata**

Pianta scarpa in gomma in 2D

VISTA DAL BASSO

Prof. Pisani Antonio

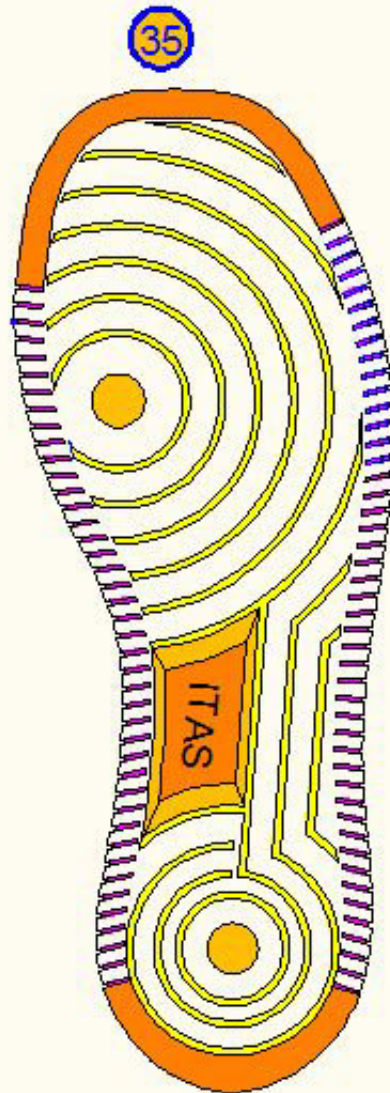

Colorare a piacimento